



WELCOME PGE 2A

G. Duffing



**Programme ICN
Grande Ecole**

**NANCY / METZ /
NUREMBERG**

G. Duffing

2017

MASTER IN MGT 2A (M1) WELCOME AT ICN !



Understanding the French system

This is all the same:

PGE

=

Programme Grande Ecole

=

Master in Management

=

French State accredited!



Admission tracks

According to French law & regulations:

- All admissions at ICN must comply with a ***competitive exam***
- French ICN students
 - “Concours” → ICN1 / ICN2 → ICN3
- Foreign students
 - IPM2 (= ICN2 !) → “AST” Competitive Exam → ICN3



Competitive exam

For IPM students only!

According to our rules, entering the PGE requires a twofold competitive exam:

- Written part: GMAT + English
 - Students who validate IPM (aka ICN2) do not need to take the exams above!
- Oral part: English + Motivation
 - An interview in Nürnberg or in Nancy, in May.



Programme general structure

ICN2/IPM/M1		ICN3/M2/ (MSc)	D.D. ...
S3	Optional Gap Year	S5	S7
S4		S6	S8

Gap year is optional, upon your request, and needs to be approved.



Master 1, and gap year



ICN 2
Fundamentals & Specialisation

Workshop

Specialization & Workshop

Internship

Experiences
Professional and/or Academic

Professional experience,
Academic Semester,
Other activity...

Professional experience,
Academic Semester,
Other activity...



Personal Tutoring



General overview

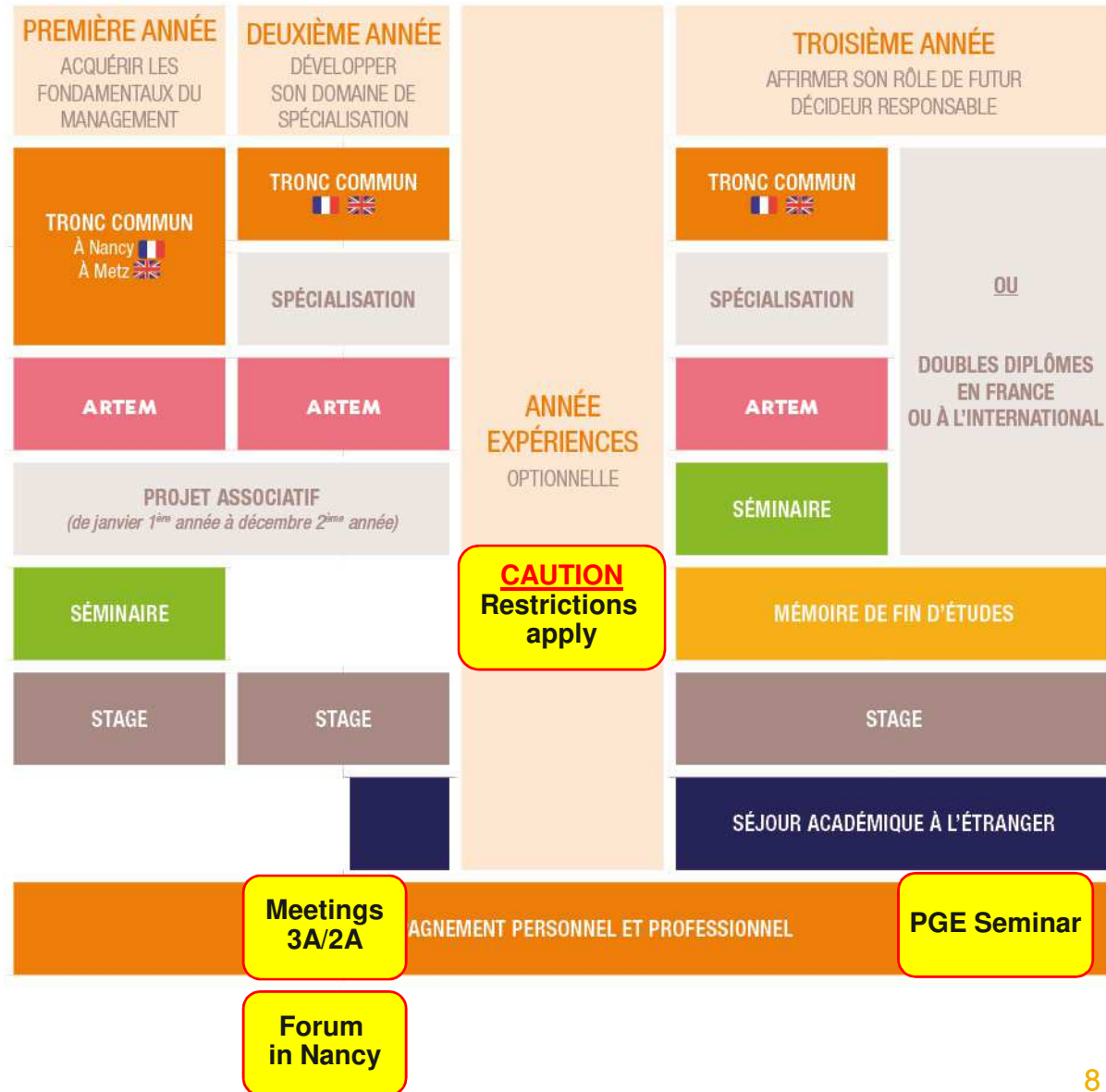



Key points

What to expect?

- **Continue your degree course**
 - Core courses + specialization
 - Workshop
 - **Prepare for an optional gap year**
 - Look for professional experience (eg, internships), or academic semester abroad. Think about the opportunity to take a gap year.
 - Academic semesters: take care of the selection process (January and March)
- 👉 **Complete your personal and professional project**



Good practices

How to learn and renew your skills and knowledge?

- Read carefully all suggested **textbooks**, and, of course, many other books
- Make sure you are enough « exposed » to all proposed disciplines: in the future, you will be able to easily use and refresh them, as and when required
- Do not forget to **practice** (projects, exercises, ...)

 **No master degree without readings and hard work!**



PGE objectives

Our learning goals

They define the « ICN profile », which is made up of 5 items:

- Graduates solve complex problems, providing an appropriate and possibly innovative solution, based on a pertinent analysis and synthesis of the situation. (***Innovate***)
- Graduates take with decisions as a sense of corporate responsibility and respecting ethical rules, demonstrating qualities of effective communication in written and oral form. (***Manage***)



PGE objectives

Our learning goals (cont'd)

- Graduates adapt and integrate into multidisciplinary and multicultural environments. (***Adapt***)
- Graduates continually update their knowledge and skills and are able to apply them to areas other than management. (***Life Long Learning***)
- Graduates show confidence and demonstrate their leadership skills in project- and teamwork. (***Show Commitment***)



PGE objectives

Goals break up into *learning objectives*

These are our measurable programme *learning goals* :

- 1.1- To analyze and prioritize the major facets of a management problem, making confident use of all useful tools available.
- 1.2- To design an appropriate and, where possible, creative solution to a given problem.
- 2.1- To make well thought-out and well-argued decisions, fully aware of their impact on the organisation and its environment.



PGE objectives

Goals break up into *learning objectives*

- 2.2- To communicate effectively via convincing written and oral presentations.
- 3.1- To demonstrate a capacity to work either in an environment which is culturally different, or on a multidisciplinary project
- 4.1- To demonstrate their knowledge and understanding of the business environment, and an ability to develop these skills further.
- 5.1- To demonstrate a positive contribution to the project in which they are involved, and show team leadership and team motivation skills.



PGE objectives

Learning objectives in modules

For each programme module, your instructor lists all expected skills: the syllabus provides a global course description:

- **Content** and general pedagogy
- **Skills, outcomes** that are expected at the end of the course
- **Evaluation rules**
- ...



**Programme ICN
Grande Ecole**

G. Duffing

2017

PEDAGOGICAL ELEMENTS



Fundamentals

Three 60-credits years (master degree = 180 ects)

- A year = 60 ECTS credits, that is 2 semesters of 30-credits
- An semester = a set of Teaching Units (TU)
- A TU = a set of teaching modules (aka “courses”)

Caution : officially, credits acquired during a gap year cannot be taken into account: they are *extra* credits.



Courses and personal work

Each course may be based on a textbook

- Preparation in advance
- In-class questions & discussions
- Further readings and work after each session
- Evaluation

- Resources:
 - Libraries, Internet, e-Learning...
 - Professors



Textbooks for 2A

- MyFinanceLab for Berk Corporate Finance 3rd ed
- Business Environment
- Management Accounting
- Management Information Systems
- Exploring Strategy

Resources:

<http://learninghub.icn-groupe.fr/> -> Page « Textbooks »
Documentation-metz@icn-groupe.fr







Connection to MyICN / Tab « Ressources » / Textbooks

Actualités ▾ Associations & Accompagnement ▾ International ▾ Mailing ▾ Ressources ▾ Programme ▾ Ancien myICN

🏠 / Textbooks / Liste des textbooks

[+ Ajouter](#)

Voir entrées par page Search:

Nom du TextBook	Actions
Bookshelf tutorial	    

Click on title or  to access to the online version of your textbook

- **MyMarketingLab** for Kotler, Marketing Management 15th ed
- **Human resources management and organizational behavior**



1st semester TU

S3		
Module	ECTS	Vol. H
TOOLS AND METHODS	8	60
Information systems management	2	15
Business environment	2	15
Data analysis	4	30
MANAGEMENT 1	6	45
Organizational behavior	2	15
Intercultural communication	2	15
Management control	2	15
ARTEM	7	60
Artem workshop	5	45
Project management	2	15
MANAGEMENT 2	6	45
Strategic marketing	2	15
Investment and financing decisions	2	15
Cost accounting	2	15
PERSONAL DEVELOPMENT	3	25
Professional skills	1	10
Foreign language	2	15



2nd semester TU

S4		
Module	ECTS	Vol. H
MANAGEMENT 1	4	30
Strategic analysis	2	15
Risk & company valuation	2	15
MANAGEMENT 2	5	40
Industrial and services marketing	2	15
Intercultural management	1	10
Organizational design	2	15
ARTEM	5	45
Artem workshop	5	45
SPECIALISATION	12	90
Specialization 1	4	30
Specialization 2	4	30
Specialization 3	4	30
PERSONAL DEVELOPMENT	4	30
Elective	2	15
Foreign language	2	15



**Programme ICN
Grande Ecole**

G. Duffing

2017

EXAMINATIONS



Examination rules

A module may organize several exams

- Continuous assessment, final exam (written or oral), report, participation... (*cf* syllabus)
- **One single grade per module**
- Disqualifying grade: 5/20

- Each TU is evaluated using an average of its modules:
 - TU grade $\geq 10/20$: PASS
 - TU grade < 10 : FAIL

- Retake (**In August, after Aug. 15th, usually**)



Plagiarism and fraud

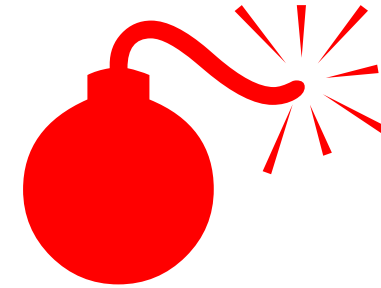

Plagiarism is always a bad solution!

- **Plagiarism is:**
 - Copying / pasting some content without reformulating it
 - Not citing sources
 - Not quoting
- **Consequences**
 - Module invalidated, AND:
 - Disciplinary board



PGE's three quitus

A quitus states that a mandatory activity has been realized

All quitus must be validated by the end of master 2

- **English proficiency:** you are proficient in business English
- **International experience:** part of your experience has been done abroad
- **Professional experience:** you are ready to join a company



English proficiency

Minimum score (toeic, toefl, or gmat)

- **A minimal score is required for:**
 - Graduating (for all students, except native speakers)
 - Being selected for UP academic semester
 - Accessing to ICN MSc
- **You must anticipate:**
 - Evaluate and adjust your level
 - Seriously prepare for the exam
 - Get some information about UP expectations

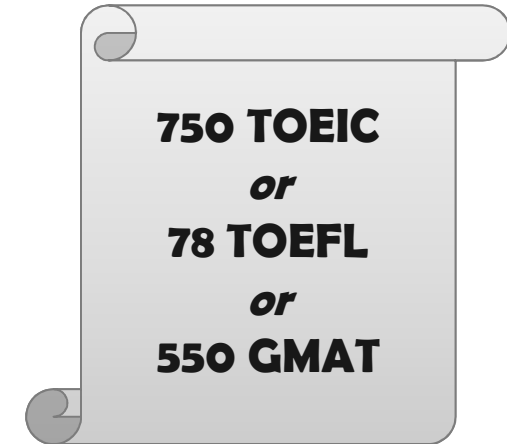



Professional quitus

Nine months of professional experience

- **We talk about « professional » experience:**
 - Various contracts are admitted: internship agreements, regular contracts, CDD, CDI, VIE, ...
 - Always with a prior, clear mission, validated by your supervisor.
- **Many constraints apply for Gap Year, in case of internship agreements:**
 - Must begin at the end of master 1
 - One single internship (max 6 months allowed)
 - Contact us for more information





International quitus

General case: one academic semester abroad

- **Many opportunities:** S4, G/Y, S5, S6.
But: when done in a G/Y, no credits can be accumulated!
- **Normally, as foreign students, or French students in Nürnberg, you have already validated this quitus!**



Semester evaluation

The assessment board

- **Examines results and decides:**
 - PASS: go to Year 3
 - FAIL: year or semester repeat
 - Retake sometimes difficult!
 - DISMISS: no possibility to continue in ICN PGE program

- **If required: the disciplinary board**
 - Regulations break
 - Inadequate behavior (school, internship, academic, ...)
 - Plagiarism, fraud



The assessment board

Common rules generally applied

- The general semester average will **not** determine the semester's validation
- The **total number of FAILED modules** will be the main criterion
- Grade levels are important, especially in specialization courses
- The assessment board takes into account **academic facts only**
- Students' non-academic (over)involvement will not be taken into account



**Programme ICN
Grande Ecole**

G. Duffing

2017

NEXT STEPS



Choices in Nuremberg

During 2A, you will have to...

- In January (1st session, then in March for a 2nd selection session) :
 - **Academic semester abroad** in UP (G/Y or 3A)
- In March / April
 - Do you want to take a gap year?
 - Which kind of 3A? Double degree? Academic semester?
 - Language course in 3A



Selection process

Mainly based on academic facts

- **Selection criteria**
 - Academic results (choice of modules depending on the requested specialization)
 - Seats offered
 - *If required*, motivation or other information
- **Choice modification**
 - An exception, with good reasons
 - On authorization only (Pr + scholar + prog. dir.)
 - Request must be submitted after the the first session of the course.



End of 2A

What to do during summer?

- **A short professional experience**
 - A must, if not already done during 1A
 - A must, if you do not choose to take a gap year
 - May be extended, in case of a gap year
- **Prepare some future academic semester abroad**
 - Cultural immersion
 - Language practice

👉 **10 weeks minimum (3 months is better!)**



The gap year

What you should know about the G/Y

- **It's optional:**
 - You must apply during master 1 (around March)
 - Credits earned in G/Y cannot be taken into account for the master degree
- **Its content is (quite) free, with some limits:**
 - Internships are strongly regulated by the French Law:
 - OK, if linked to 2A (starts during master 1)
 - OK, if you validate 200 hours of training during G/Y (UP, e.g.)
 - One single internship, 6 months max, is allowed
 - **But:** this only applies for internship agreements. Any other form of contract is not subject to these constraints.



Internships in 2A

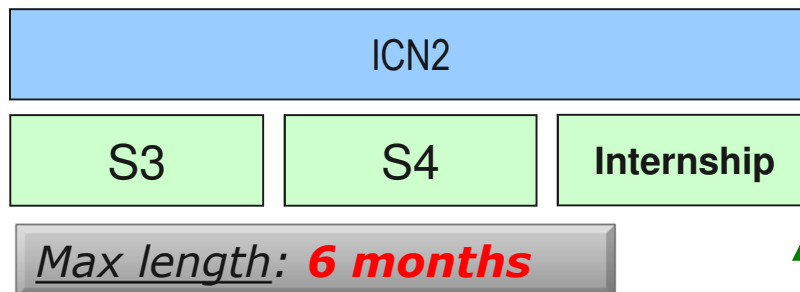

↑
Limit: Aug. 31st

2A prof. experience (minimum 10 weeks) is important to:

- Validate a short experience (if not done before)
- Contribute to the required minimum of 9 months of prof. exp

Some rules:

- Do not choose a very short experience
- Do not change ending dates



Internships and gap year

Gap Year (G/Y)

~~Internship~~

Internship

Academic sem.

Academic sem.

Internship

200 hrs courses

Internship

Internship

~~Internship~~

... ?

~~Internship~~

At most one internship,
with restrictions:

*Contact our
service carrières et stages
(SC&S)*

*Max length: **6 months***



Limit: Aug. 31st



Master 2 in Nuremberg

After master 1 in Nuremberg

- **Best choice: complete your specialization in Nuremberg**
 - MSc Marketing and Brand Management
 - PGE Finance, Insurance, and Risk Management

- **Other opportunities**
 - MSc or certificate in Nancy, Dakar, Chengdu, Paris...
 - Selection in UP, for 1 semester or 2 (double degrees)



Internships in 3A

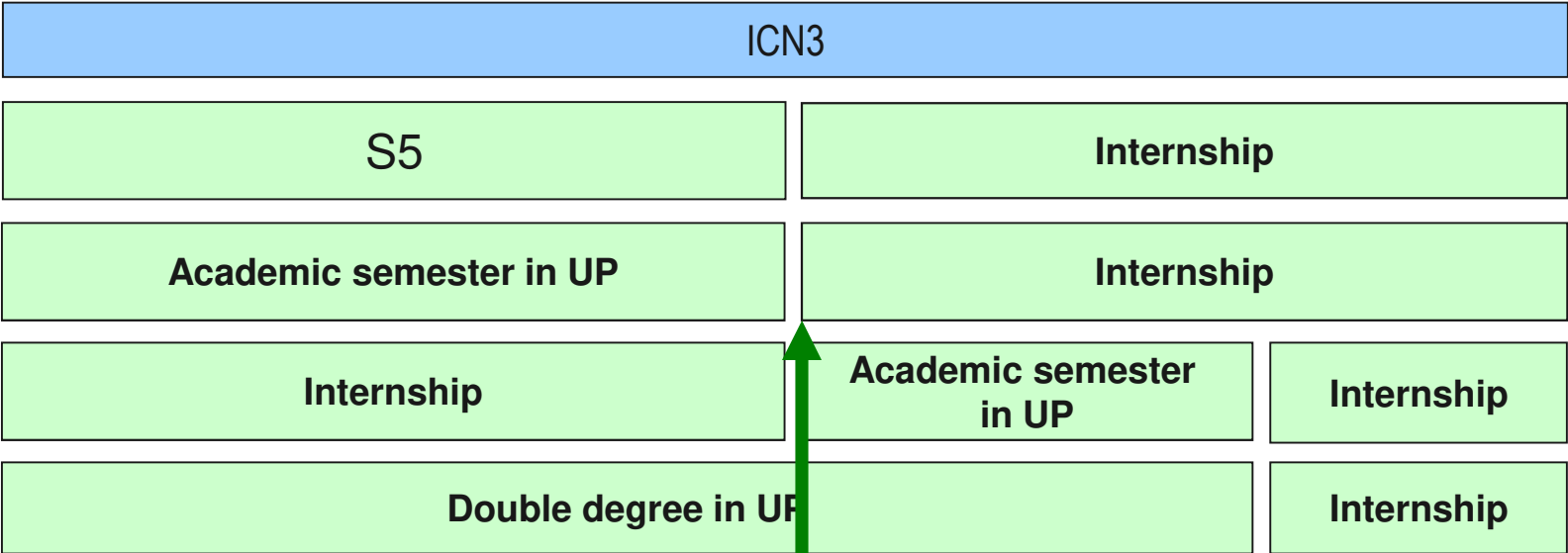

Starts before: Aug. 31th

Limit: Sep. 30th



Extension (ICN3+)

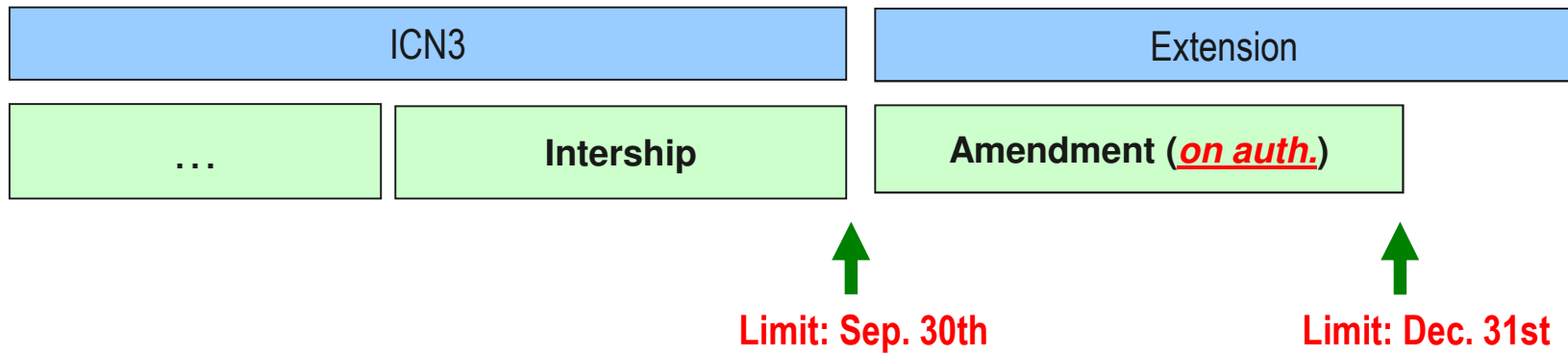



Longest degree course

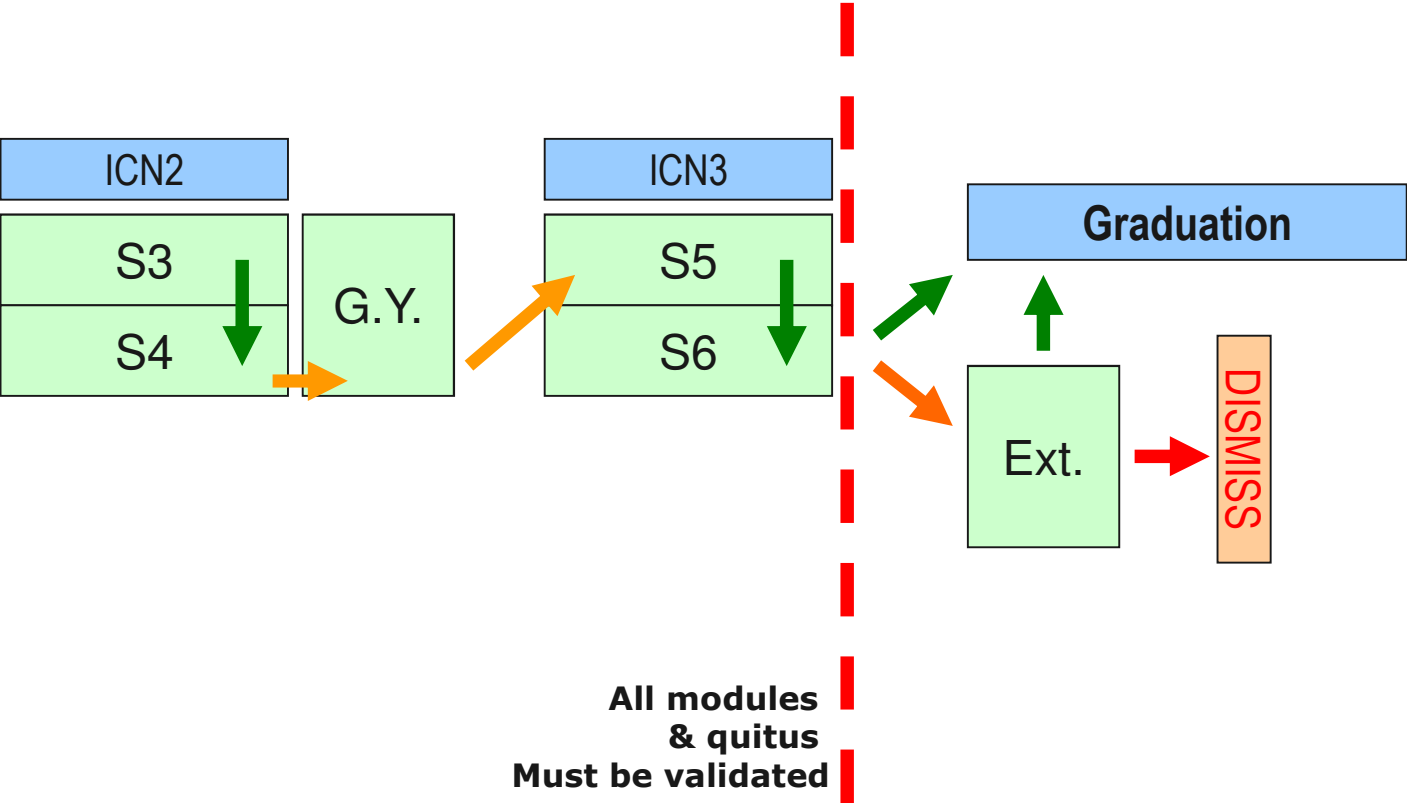



Special personal projects

Entrepreneurial and/or Artem, according to your ambition...

- **Follow up of some 1A project, or start of a new project... You may take advantage of:**
 - Electives and learning agreements
 - Workshops, specializations, double degree, Artem courses choices...
 - Later on: adapted master thesis choice
 - Up to our « incubators », if necessary.
-  Contact us for more information.



**Programme ICN
Grande Ecole**

G. Duffing

2017

WARNINGS



Quitus validation

Too often, a problem at the end of PGE!

- **Evaluate your situation** today!
- When do you satisfy to all required quitus?
- How?
- What time do you have to get prepared, apply, etc.
- Any alternate plan, just in case... ?

☞ Exceptions are now on really rarely granted by the assessment board. **DO NOT COUNT ON THEM!**



Contracting with companies

A strong commitment

- Commitment is very important, even if no contract has been signed yet.
- Do not chase many contracts in parallel, « cheating » companies
- Define precisely your mission, and ask your supervisor to validate it
- Do not end a contract by your own, without warning your supervisor, and SC&S
- The company that welcomes you also counts on you
- Do not end a contact for « personal reasons »
- ICN will keep a close watch on students / company relationships
- Never start a internship without a signed internship agreement (or other contract).



RUMORS...

The « former students told me that... » syndrome

- **Regulations do change**, but we inform you:
 - Consider MyICN, and look at our messages attentively
- **Assessment board decisions do change**, depending on results, ICN politics, ... You cannot anticipate, and compare with Year - 1
 - Do not believe all that students may say!
 - Just try to validate all modules and quitus!



**Programme ICN
Grande Ecole**

G. Duffing

2017

PRACTICAL INFORMATION



Professional experience validation

Simple rules to keep in mind:

- **EACH experience must be assessed separately**
 - Evaluated by school + enterprise
- **For each experience, you submit:**
 - A report, assessed by your supervisor
 - A self assessment, plus a synthesis
- **Prof'I Quitus validation**
 - At the end of the program, after examination of all internships.



Who's who / contacts

They are her to help you:

- **Academic affairs**
 - Your supervisor, or Pr responsible for your specialization
 - *Prog. Dir. assistant:* Marie Forticaux (Nancy)
 - *Prog. Dir.:* Gérald Duffing (Nancy)
- **Administration**
 - **Nuremberg: Melanie Bürgel, Tabithe Hudspeth (Dir. Sacha Wawra)**



Where to find information?

Mainly on MyICN

- **About our campuses and courses locations:**
 - ☞ Information on sites: MyICN
- **Course schedule**
 - MyICN and paper
 - Updated on Friday (unforeseen events may always occur!)
- **Communication rules**
 - MyICN: repository for almost all information you may need
 - Emails, with your ICN account: firstname.lastname@myicn.fr. **Manage your emails!**

